

Installation Instructions

Wireless Motion Sensor LED Spotlight

MB330/360

Thank you for purchasing the Mr. Beams™ Wireless Spotlight. We are committed to eliminating darkness using the latest in Light-Emitting Diodes (LEDs). LEDs are the most efficient and durable light sources available. We are certain that your light will contribute to a safer environment and provide light where you need it at a very reasonable cost.

What is included per light:

- 1 Wireless Spotlight
- Mounting Base
- 3 Screws
- 3 Anchors

What you need to install:

- 1 Small Screwdriver
- 3 D-Cell Alkaline Batteries

Spotlight Features:

Motion/Light Sensor: Light instantly turns on when it detects motion from up to 30 feet away. The light sensor conserves battery life by preventing the light from activating in daylight.

Auto Shut-off: Light shuts off automatically after 30 seconds if no motion is detected.

Fully Adjustable: Light can be rotated 360° as well as up and down.

Bright LED: 140 Lumens covers up to 400 sq ft.

Durable, Weather Resistant: Tight seals and UV resistant material allow the light to work in all weather conditions.

Tips:

- Use only new alkaline D-Cell batteries with 1.5V rating.
- Do not mix old and new batteries. If batteries are not new, it may cause the light to malfunction.
- Install batteries with polarity in correct position.
- Light may activate when batteries are inserted. Simply take light into a dark room. Allow batteries to settle, then test activation.
- **If your light will not turn off, it means that it is time to replace the batteries.**

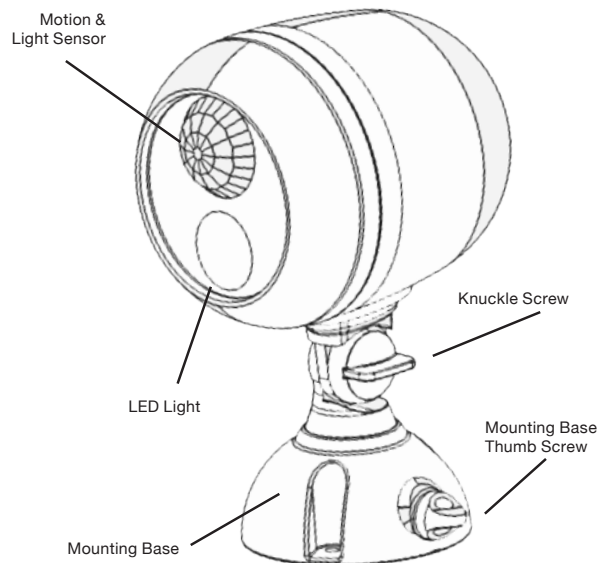

NOTE: Light sensor only allows Spotlight to activate in darkness. We recommend you test in a dark room or closet.

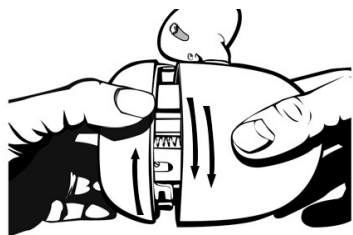

1. Remove front cover of Spotlight by rotating counter-clockwise as shown above. Pull face out from cup to reveal battery holder.

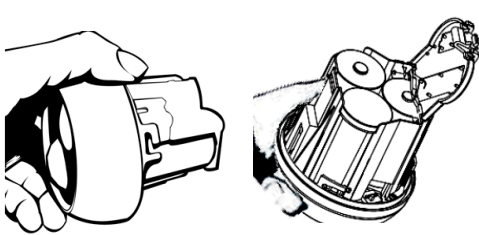

2. Push down on battery door tab to release. Insert 3 D-Cell batteries into Spotlight. Attach battery door by matching the tabs to the rectangular holes and then push down on front until door clicks into place. Light will turn on and stay on as long as there is motion.

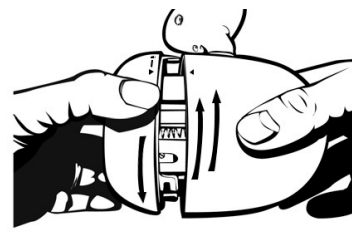

3. Match arrows then turn clockwise. **Make sure unit is securely closed with arrow pointing past the symbol to ensure weather proof seal is tight.**

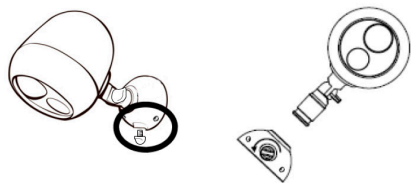

4. Determine location for mounting Spotlight. **NOTE:** For best performance, Spotlight should be positioned so motion sensor is on top and light is on bottom.

5. Remove mounting base by turning thumb screw counter clockwise.

6. Pull mounting base off stem.

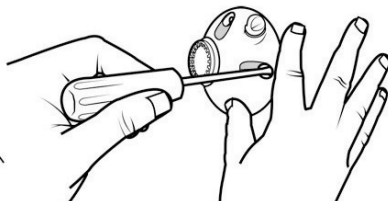

7. Drive three screws into the three holes located on mounting base.

8. Insert spotlight stem back into mounting base pointed in desired direction and tighten thumb screw in base.

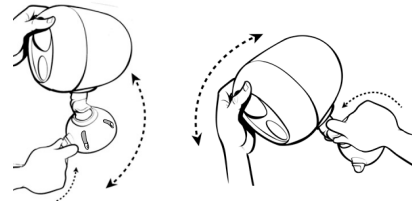

9. Loosen Knuckle screw that connects Spotlight head to mounting base and adjust Spotlight head to proper direction as shown above. Tighten thumb screw.

* Visit our website to view installation video.

* 1 year limited warranty. See enclosed card for details.

MR BEAMS™
Surprisingly Bright Light Anywhere
www.mrbeams.com



32333 Aurora Rd. Suite 100 Solon, OH 44139
877.298.9082