

Installation Instructions

NetBright® Motion Sensing Spotlight

MBN350/340

Thank you for purchasing the NetBright® Motion Sensing Spotlight. Your spotlight was created to allow for multiple lights to work as a group in order to improve the conditions of your home, workplace or anywhere you need light. This technology contributes to a safer environment and provides bright light anywhere.

What is included per light:

- Wireless Spotlight
- Mounting Base
- 3 Screws
- 3 Anchors

What you need to install:

- 1 Small Screwdriver
- 3 D-Cell Alkaline Batteries

Spotlight Features:

Motion/Light Sensor: Light instantly turns on when it detects motion from up to 30 feet away. The light sensor conserves battery life by preventing the light from activating in daylight.

Auto Shut-off: Light shuts off automatically after 20 seconds if no motion is detected.

Fully Adjustable: Light can be rotated 360° as well as up and down.

Bright LED: 200 Lumens covers up to 400 sq ft.

Durable, Weather Resistant: Tight seals and UV resistant material allow the light to work in all weather conditions.

Multiple Lights: Spotlights will activate simultaneously when any spotlight within the network detects motion. They will deactivate simultaneously if no motion is detected in the group.

Tips:

- Use only new alkaline D-Cell batteries with 1.5V rating.
- Do not mix old and new batteries. If batteries are not new, it may cause the light to malfunction.
- Install batteries with polarity in correct position.
- Light may activate when batteries are inserted. Simply take light into a dark room. Allow batteries to settle, then test activation.
- **If your light will not turn off, it means that it is time to replace the batteries.**

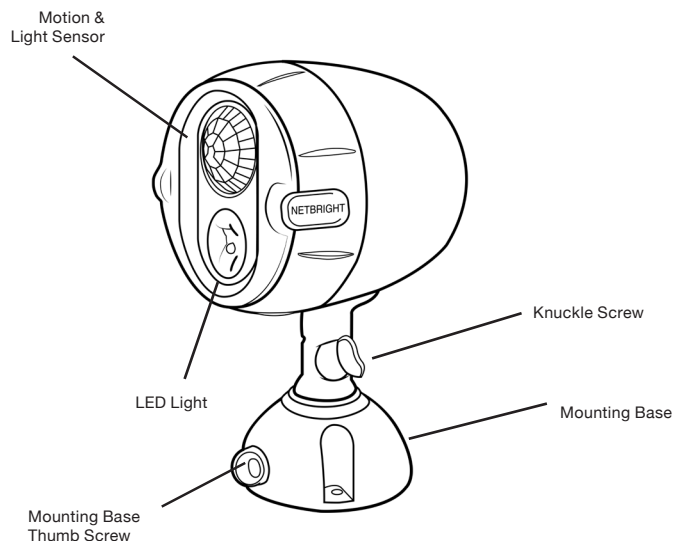

NOTE: Light sensor only allows Spotlight to activate in darkness. We recommend you test in a dark room or closet.

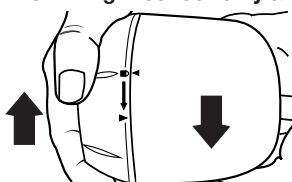

1. Remove front cover of Spotlight by rotating counter-clockwise as shown above. Pull face out from cup to reveal battery holder.



2. Push down on battery door tab to release. Insert 3 D-Cell batteries into Spotlight. Make sure when you are inserting the batteries, that the flat ends match up with the springs. Attach battery door by matching the tabs to the rectangular holes and then push down on front until door clicks into place. Light will turn on and stay on as long as there is motion.

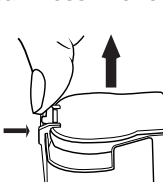

3. Match arrows then turn clockwise. **Make sure unit is securely closed with arrow pointing past the lock symbol to ensure weather proof seal is tight.**

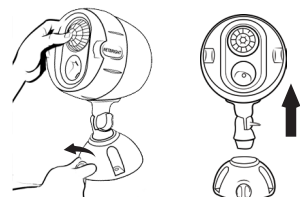
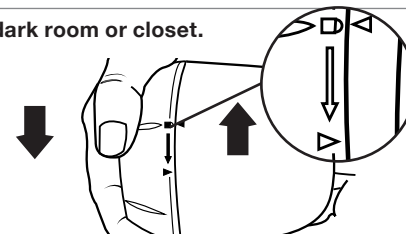

4. Determine location for mounting Spotlight. **NOTE:** For best performance, Spotlight should be positioned so motion sensor is on top and light is on bottom.
5. Remove mounting base by turning thumb screw counter clockwise.
6. Pull mounting base off stem.

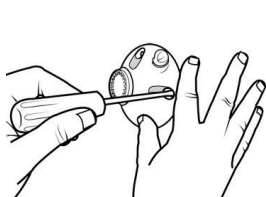

7. Drive three screws into the three holes located on mounting base.
8. Insert spotlight stem back into mounting base pointed in desired direction and tighten thumb screw in base.

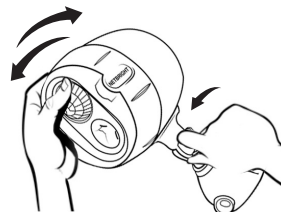

9. Loosen Knuckle screw that connects spotlight head to mounting base and adjust spotlight head to proper direction as shown above. Tighten thumb screw.

Setting up Lights to a Network

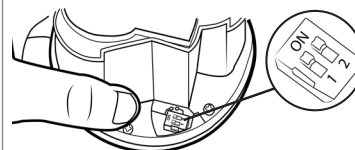

After inserting the batteries, choose a group or channel for your spotlights with the dipswitches next to the battery compartment. Ensure all units are on the same channel by matching dipswitches.

* Spotlights set to the same group that are within 150 ft range of each other will work together automatically

Battery Caution:

- 1) Do not mix old and new batteries
- 2) Do not mix Alkaline, Standard (Carbon-Zinc) or Rechargeable (Nickel Cadmium) or (Nickel Metal Hydride) batteries
- 3) Do not dispose of batteries in fire
- 4) Batteries should be recycled or disposed of as per state and local guidelines